

NEW

BASE Kubota

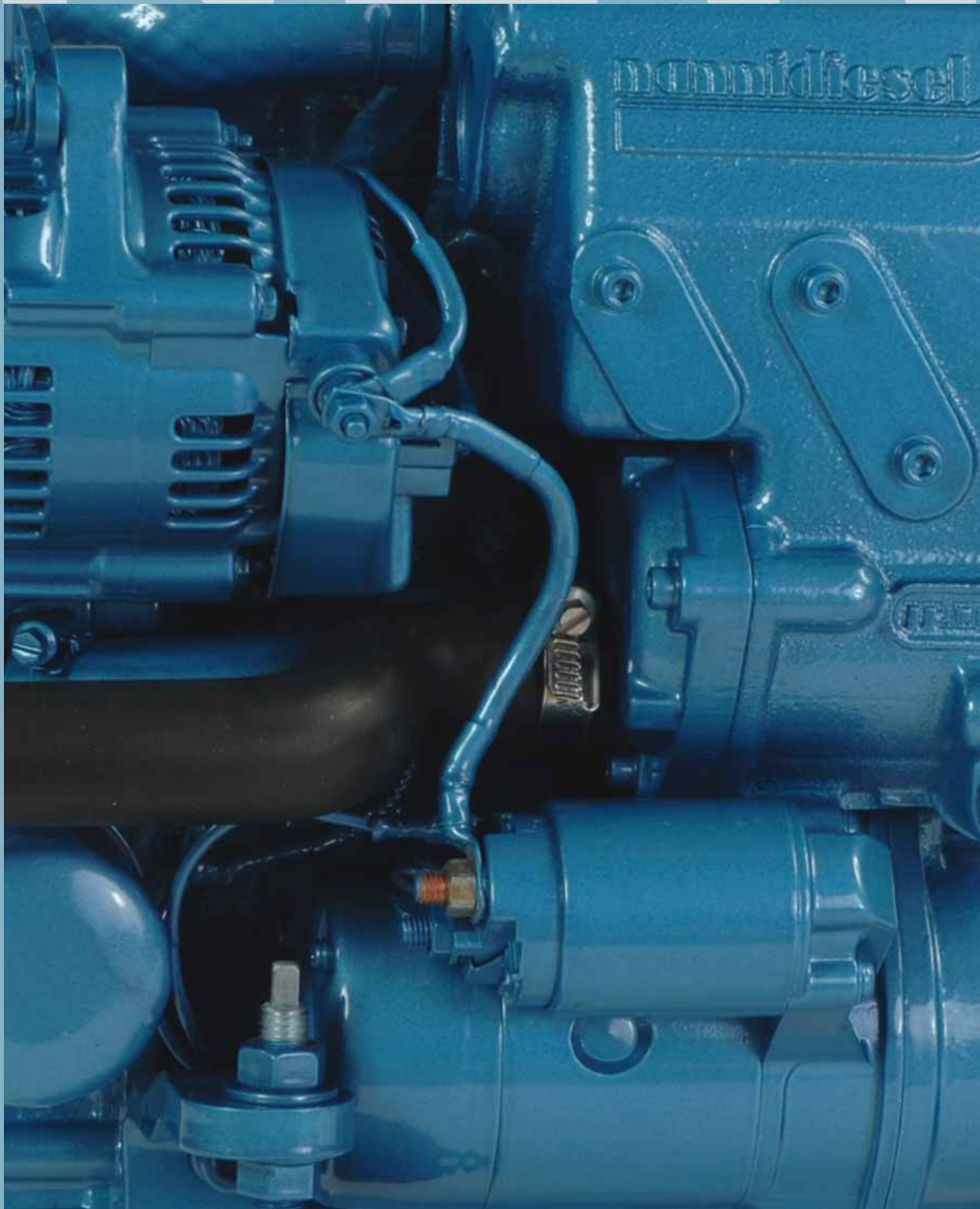

012

nannidiesel

energy in blue

N2.10

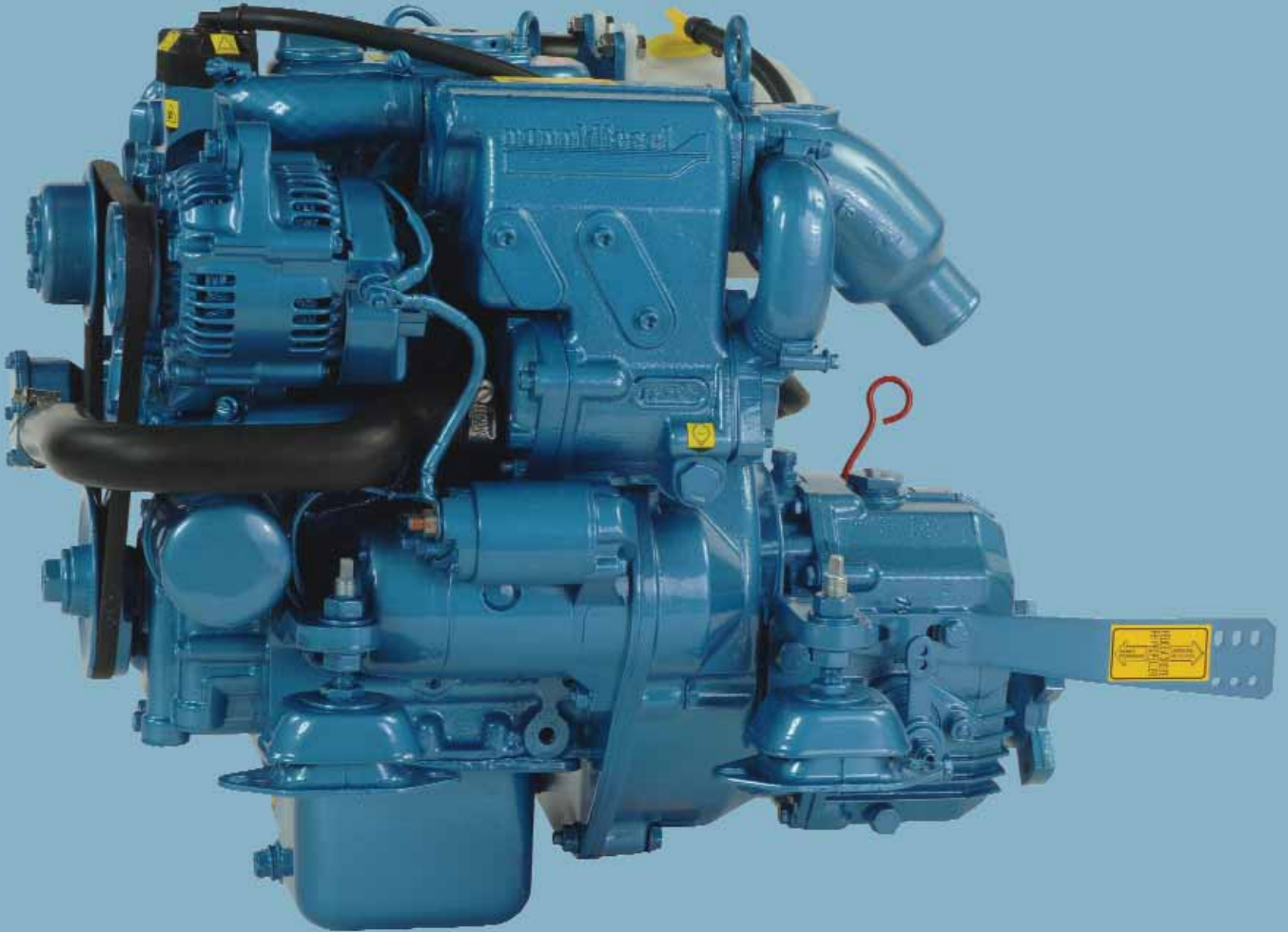

Sail Drive application also available

nannidiesel

energy in blue

N2.10



10 HP (7.36 kW) at 3000 rpm

2 CYLINDER DIESEL base 

ENGINE BASE

This prestigious partner of industrial engines provides you with high quality, reliability and the latest diesel technology.

APPLICATIONS

The N2.10 is a new 2 cylinder 10 HP heat-exchanger cooled diesel engine realized to fit the smallest of applications.

PERFORMANCE

Thanks to its high torque, the cruising speed is reached at low RPM resulting in maximum comfort with the lowest possible vibrations and noise level - leading in its category.

COMFORT

With a low RPM at 3000, the N2.10 provides a very quiet cruising speed. It also has the benefit of providing hot water on board via a calorifier if required.

COMPACT

Extremely compact, the N2.10 is lower in height and shorter in length than most of its competitors; in fact it is very similar to the dimensions of a single cylinder engine, which would have no heat exchanger.

STANDARDIZATION

The engine mounts are studied in order to allow its perfect interchange ability with competitive engine brands, and this without modifying bearers or engine compartments.

ENVIRONMENT FRIENDLY

The N2.10 exhaust level is well below the requirements of the most stringent emission regulations, the **BSO 2**, the new European Directive **2003/44/EC** and the American **EPA Tier 2**.

PRESENTATION

N2.10

Base:	Kubota
Fuel type	Diesel
Power	10 HP (7.36 kW)
Max .RPM	3000 RPM
Displacement	0.479 liter (29.23 cu inch)
N° of cylinders	2
Bore and Stroke	67 x 68 mm (2.64" x 2.68")
Compression ratio	23 / 1
Combustion System	Indirect injection E-TVCS
Intake	Natural aspiration
Cooling	Dual circuit with Heat Exchanger
Electrical Equipment	12 Volts
Alternator	40 Amp.
Instrument Panel	Eco 3
Transmission	Mechanical TMC 40 reduction ratio 2.60 /1
Dry weight (with transmission)	87 kg (191.4 lbs)

Hose diameters :	
Exhaust	45 and 50 mm (1.77" and 1.97")
Fuel	8 mm (0.31")
Sea water	20 mm (0.79")
Max installation angle	15° (dynamic)

**INSTRUMENT PANEL
ECO 3**

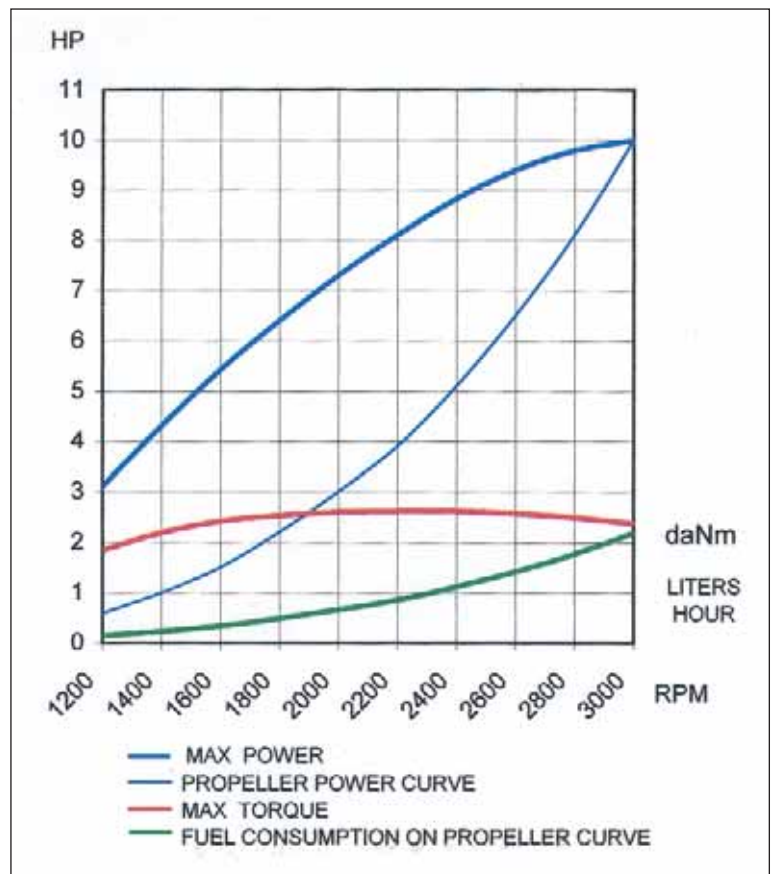
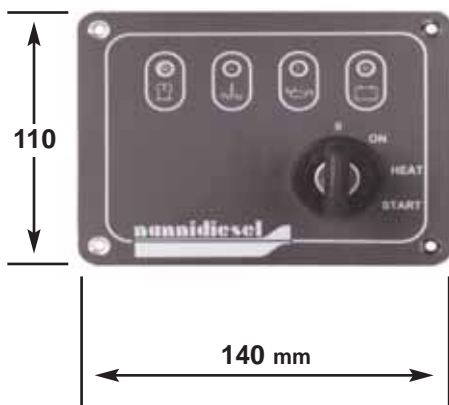

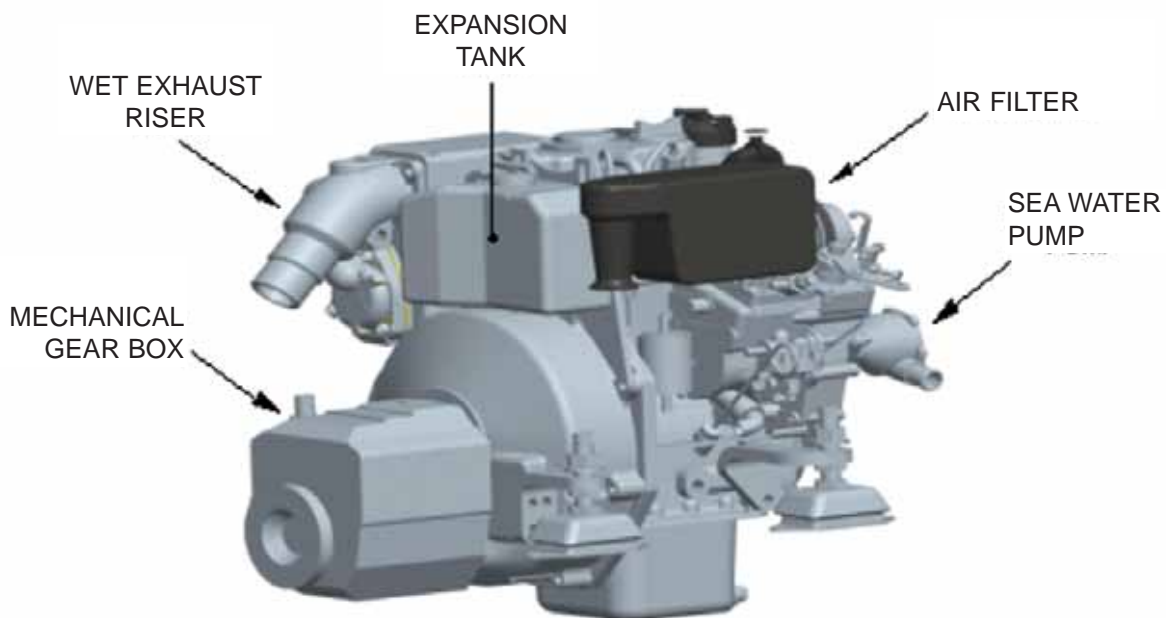
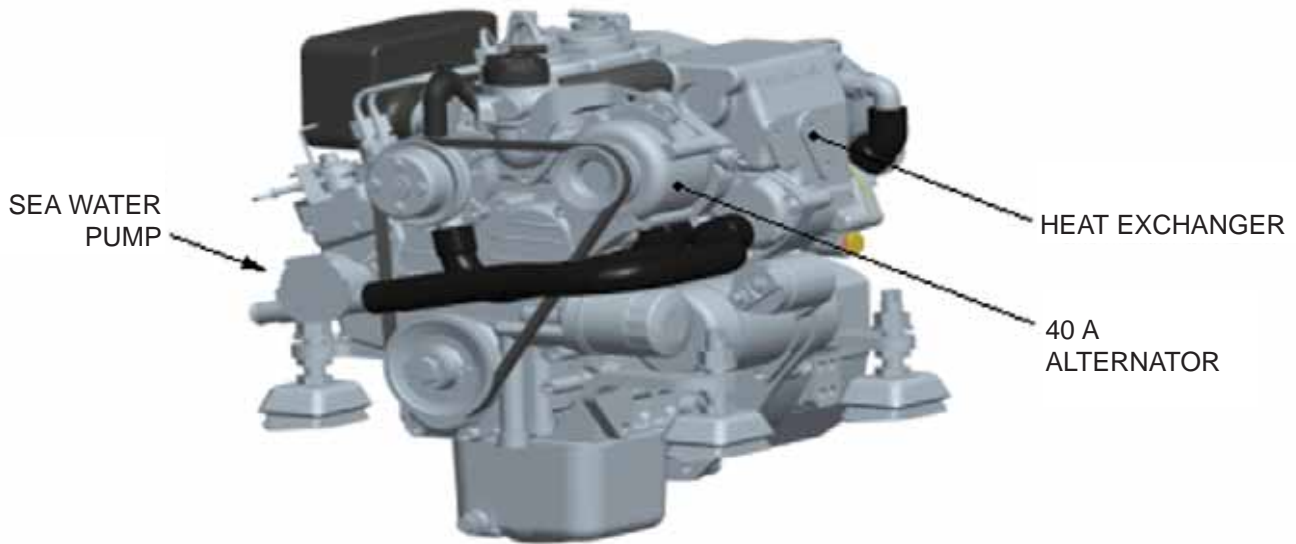

N2.10

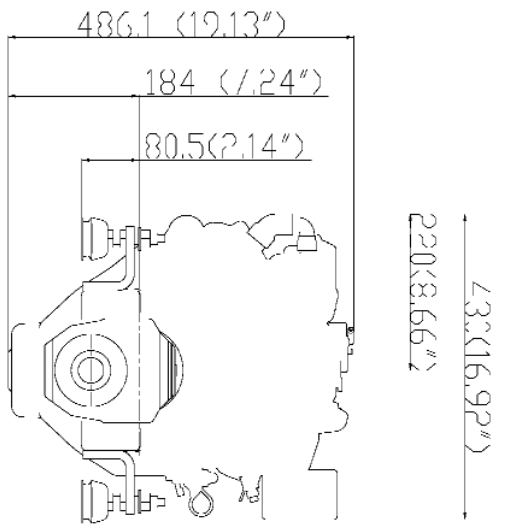
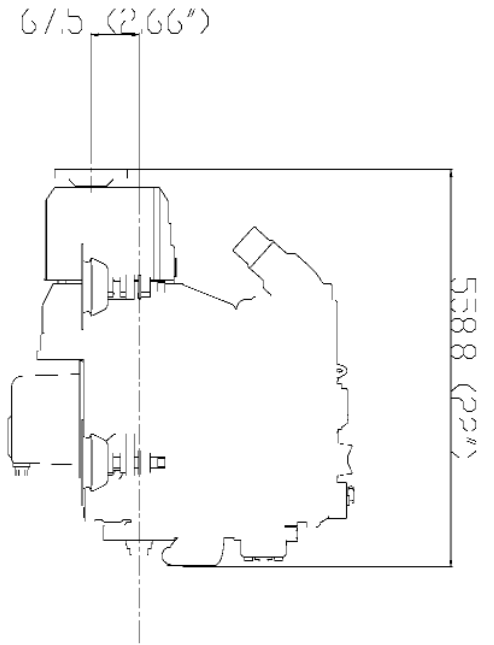
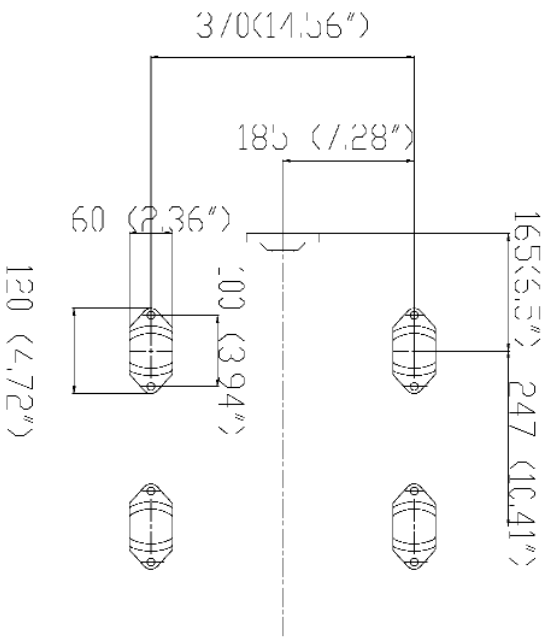

NANNIDIESEL N2.10-TWC43

COMPARISON WITH COMPETITORS

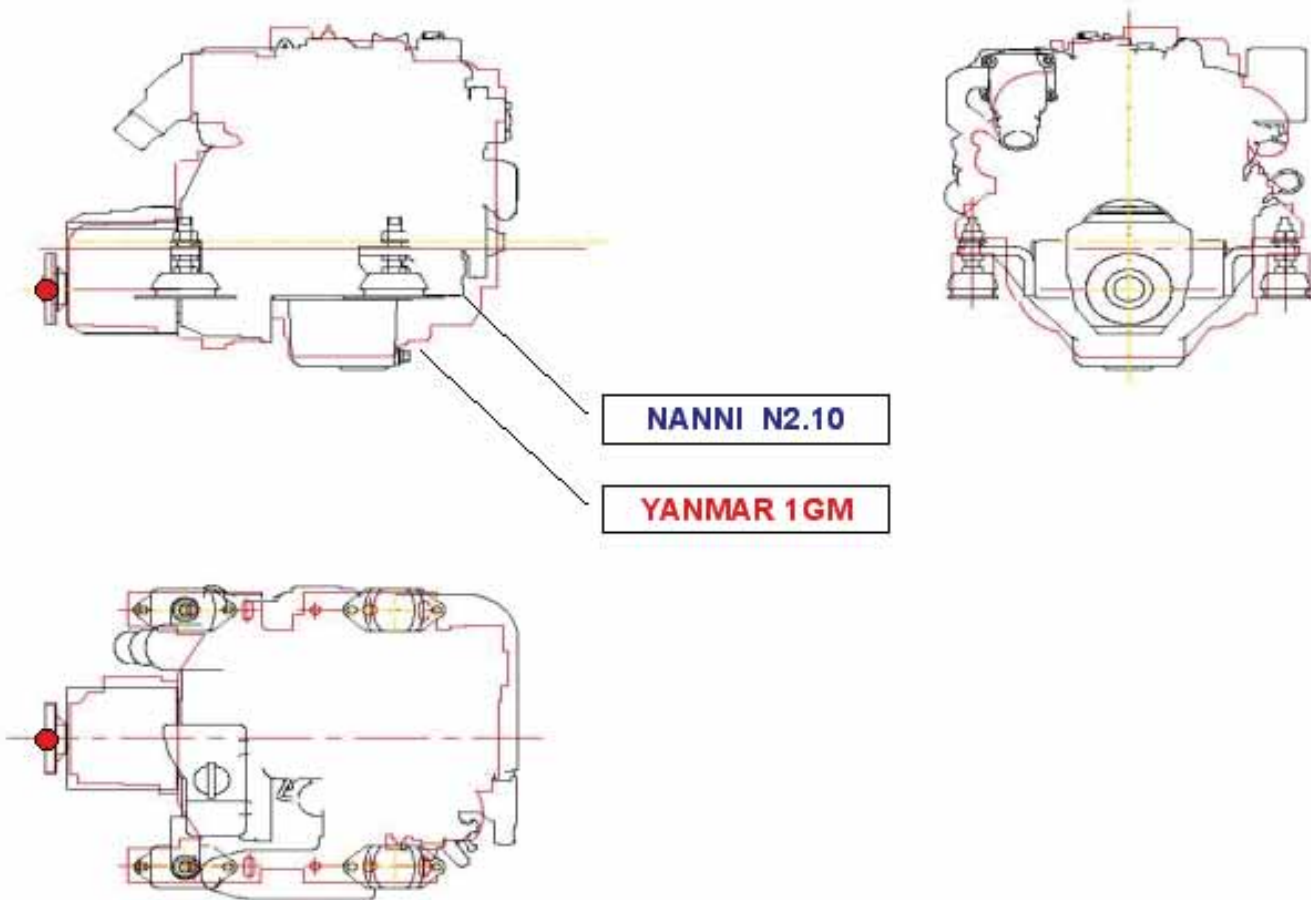

THE N2.10 DIMENSIONS (BICYLINDER WITH HEAT EXCHANGER)
ARE EQUIVALENT TO A YANMAR 1GM
WHICH IS A MONOCYLINDER WITHOUT HEAT EXCHANGER

N2.10

COMPARISON POWER, TORQUE AND CONSUMPTION CURVES OF NANNI N2.10 AND YANMAR 1GM

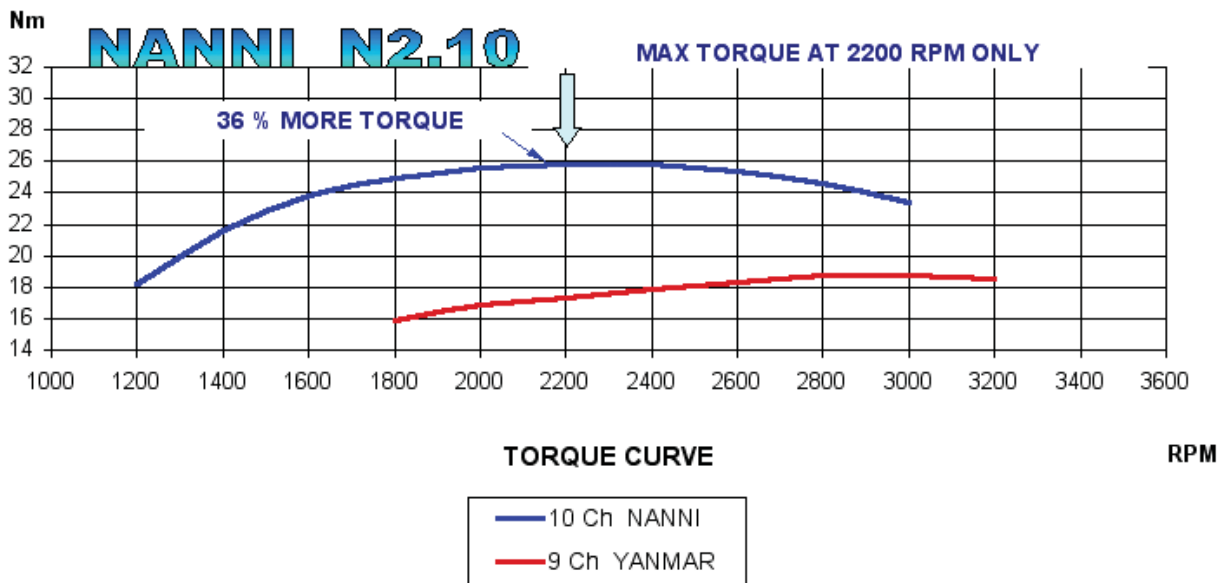
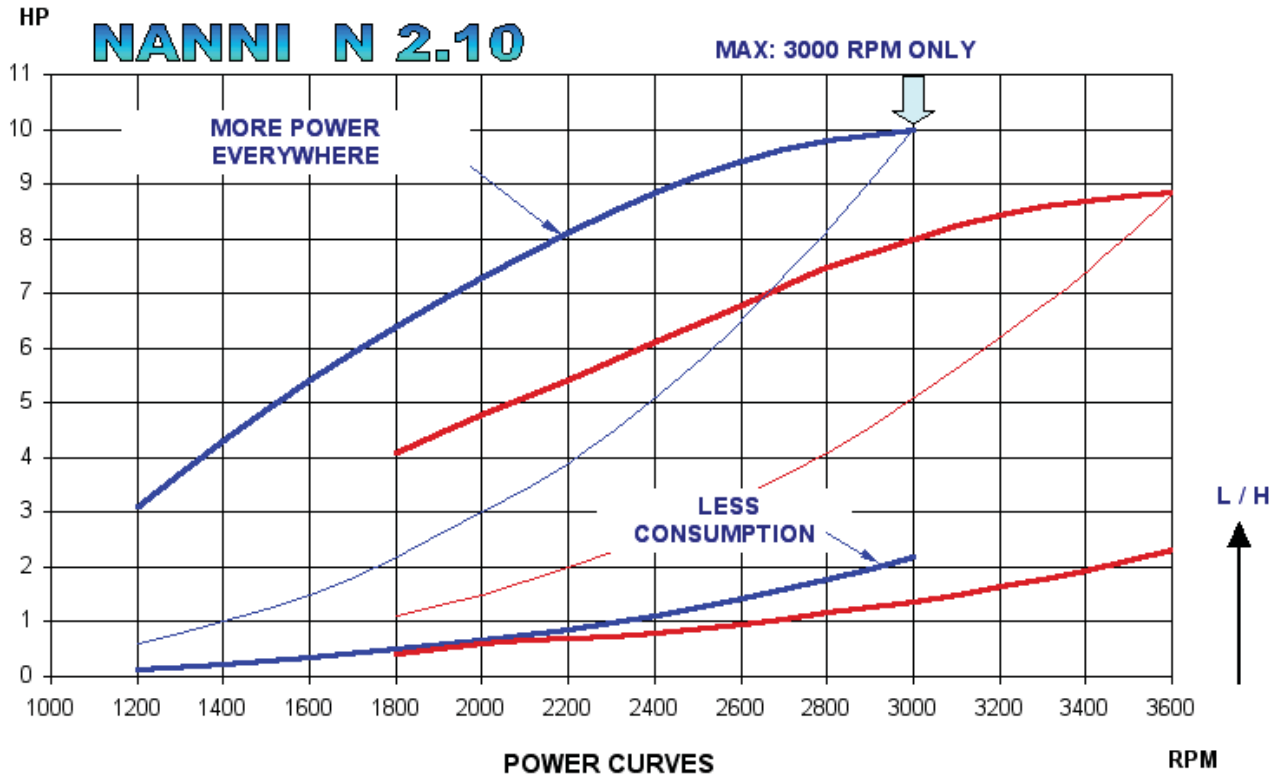

COMPARISON NANNI ENGINE N2.10 WITH OTHER BRANDS

BRAND	TYPE	POWER HP	RPM	N ^o OF CYLINDER	CYL / CM3	Weight kg	LENGTH	WIDTH	HEIGHT	OBS
NANNI	N 2.10	10	3.000	2	479	87	558	428	486	with heat exchanger
YANMAR	1GM	9	3.600	1	318	81	554	420	485	without heat exchanger
VOLVO	D1- 13	11,8	3.200	2	510	113	651	476	514	with heat exchanger



The N2.10 is equivalent to 1GM which is a one cylinder engine without heat exchanger

The VOLVO D1-13 is heavier and bigger

COMPARISONS

N2.10

COMPARISON OF THE N2.10 EMISSIONS VERSUS THE EUROPEAN DIRECTIVE 2003/44/EC

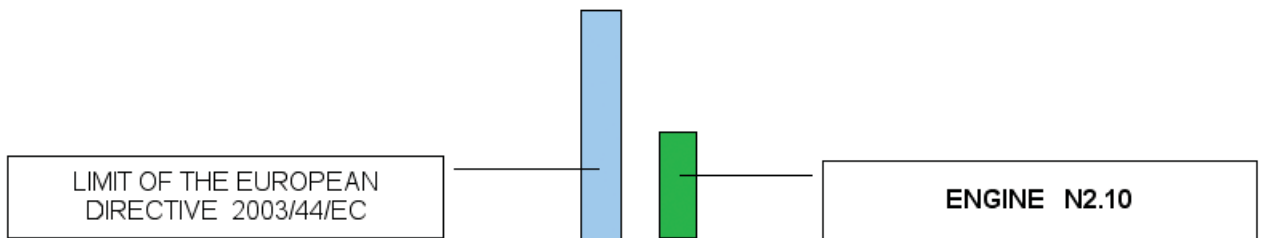
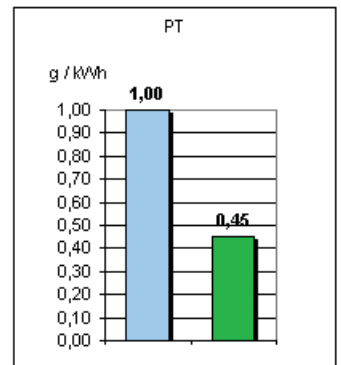
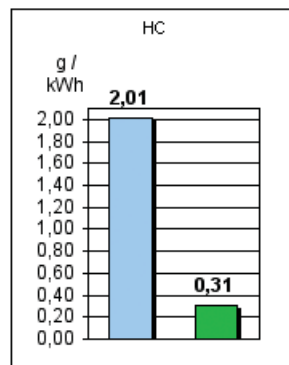
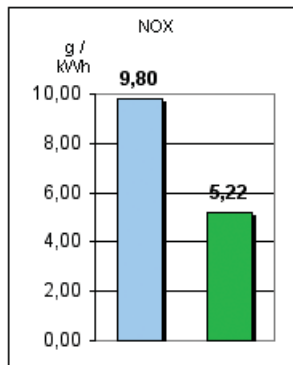
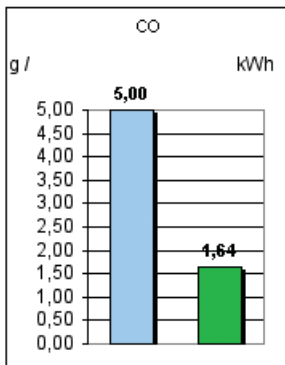

THE N2.10 ENGINE'S EMISSIONS ARE FAR BELOW THE VALUES
FIXED BY THE EUROPEAN NORMES

DETAILS MAKE THE DIFFERENCE

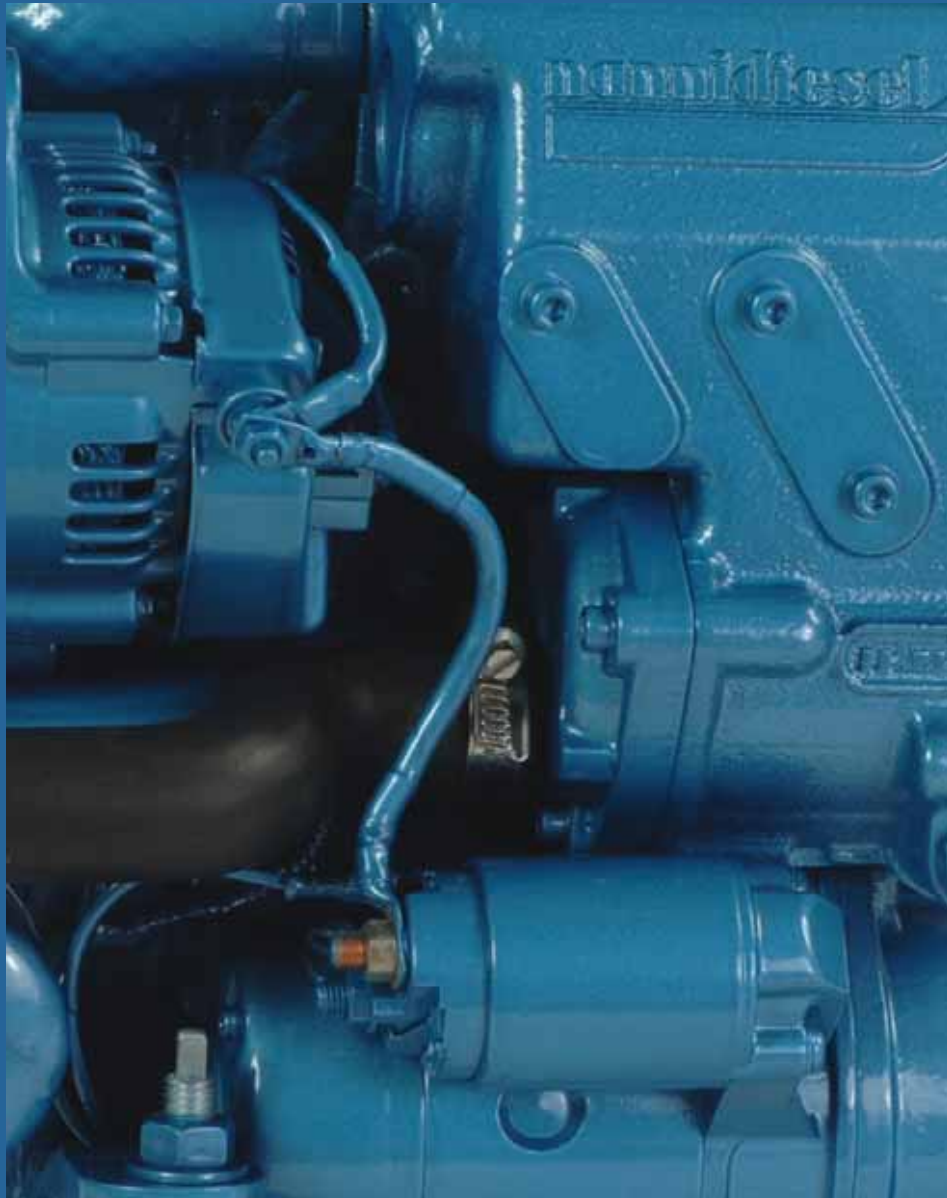

it's a Nanni:
Quality of the Product
Quality on the Service

nannidiesel

energy in blue

MARINE ENGINES FROM 10 TO 320 HP



Nanni Industries s.a.s. Z.I. - 11, Avenue Mariotte - 33260 La Teste – France
Tél. +33 (0) 5 56 22 30 60 - Fax +33 (0) 5 56 22 30 79
contact@nannidiesel.com – www.nannidiesel.com

© Ufficio Grafico Nanni Trading, Roma – design: MONICA INFANTINO

AFRICA

ALGERIA
TUNISIA
MOROCCO
IVORY COAST
MADAGASCAR
SOUTH AFRICA
EGYPT
MAURITANIA
SENEGAL
REUNION ISLAND

EUROPE

DENMARK
ESTONIA
FINLAND
FAERO ISLANDS
IRELAND
ITALY
LATVIA
MALTA
THE NETHERLANDS
UNITED KINGDOM

BELGIUM
CROATIA
CZECH REPUBLIC
PORTUGAL
RUSSIA
SPAIN
SWEDEN
SWITZERLAND
NORWAY
POLAND
GERMANY
GREECE
HUNGARY
ICELAND
TURKEY
SLOVENIA
ROMANIA

OCEANIA

AUSTRALIA
NEW ZEALAND
NEW CALEDONIA
FRENCH POLYNESIA

ASIA

INDONESIA
JAPAN
ISRAEL
BAHRAIN

AMERICA

GROENLAND
MARTINIQUE
GUADELOUPE
SAINT MARTIN
VENEZUELA
CHILE
ARGENTINA
ECUADOR
BELIZE
CUBA
U.S.A:
ANNAPOLIS
MIAMI
HOUSTON



Nanni Industries s.a.s

Z.I. - 11, Avenue Mariotte - 33260 La Teste – France Tél. +33 (0) 5 56 22 30 60 - Fax. +33 (0) 5 56 22 30 79

contact@nannidiesel.com – www.nannidiesel.com

Nanni Trading s.r.l. - Export Dept. / Italia

Via A.G. Bragaglia, 31/A - 00123 Roma - Italia Tel. +39 06 30 88 42 51/2/3 – Fax. +39 06 30 88 42 54

info@nannitrading.it – www.nannitrading.it